

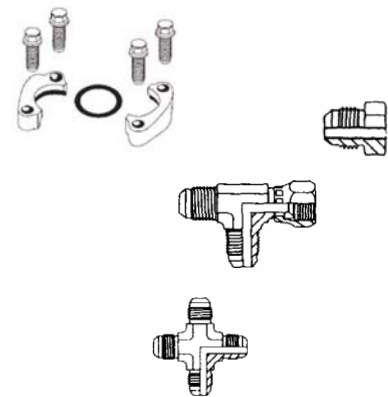

HYDRAULIC ADAPTORS

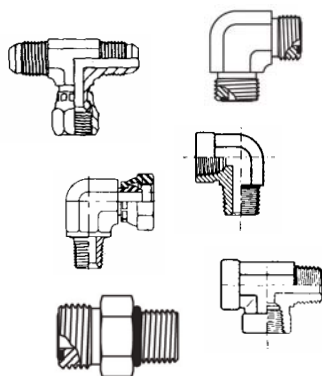
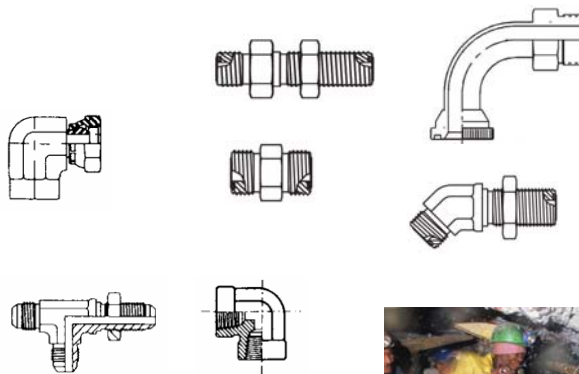

BRAESIDE (H.O.)
1-3 Japaddy St
Mordialloc, Vic 3195
P: (03) 9588-1440
F: (03) 9588-1441

BAYSWATER
1/477 Dorset Rd
Bayswater, Vic 3153
P: (03) 9729-8422
: (03) 9729-8544

SYDNEY
25 Clyde St
Rydalmere, NSW 2116
P: (02) 9684-2222
F: (02) 9684-2822

NEWCASTLE
2/34 Portside Cres
Maryville, NSW 2293
P: (02) 4969-1700
F: (02) 4969-1902

STEEL ADAPTORS



BSPP*/BSPP*



NIPPLE



BULKHEAD



MALE/FEMALE S/W NUT



FEMALE S/W NUT/
FEMALE S/W NUT



MALE/FEMALE

END 1	END 2	Part No.	Part No.	Part No.	Part No.	Part No.
1/4"	1/4"	X-4HMK4S	X-4WMK4WL4NMS	X-4-4F6MK4S	X-4H6MK4S	
3/8"	1/4"	X-6-4HMK4S				
3/8"	3/8"	X-6HMK4S	X-6WMK4WL4NMS	X-6-6F6MK4S	X-6H6MK4S	
1/2"	1/4"	X-8-4HMK4S				X-8-4G4MK4S
1/2"	3/8"	X-8-6HMK4S				
1/2"	1/2"	X-8HMK4S	X-8WMK4WL4NMS	X-8-8F6MK4S	X-8H6MK4S	
3/4"	3/8"	X-12-6HMK4S				
3/4"	1/2"	X-12-8HMK4S				
3/4"	3/4"	X-12HMK4S	X-12WMK4WL4NMS	X-12-12F6MK4S	X-12H6MK4S	
1"	1/2"	X-16-8HMK4S				
1"	3/4"	X-16-12HMK4S				
1"	1"	X-16HMK4S	X-16WMK4WL4NMS	X-16-16F6MK4S		
1 1/4"	1"	X-20-16HMK4S				
1 1/4"	1 1/4"	X-20HMK4S	X-20WMK4WL4NMS			
1 1/2"	1"	X-24-16HMK4S				
1 1/2"	1 1/4"	X-24-20HMK4S				
1 1/2"	1 1/2"	X-24HMK4S	X-24WMK4WL4NMS			
2"	1 1/2"	X-32-24HMK4S				
2"	2"	X-32HMK4S				

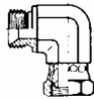

ELBOW.

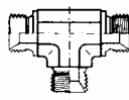

TEE



PLUG



CAP



FEMALE S/w
LIFESAVER
WELD ON

END 1	END 2	Part No	Part No	Part No.	Part No	Part No.
1/8"	1/8"			X-2PNMK4S		
1/4"	1/4"	X-4C6MK4S	X-4JMK4S	X-4PNMK4S	X-4FNMK4S	X-4K46HMB4S
3/8"	1/4"					
3/8"	3/8"	X-6C6MK4S	X-6JMK4S	X-6PNMK4S	X-6FNMK4S	X-6K46HMB4S
1/2"	1/2"	X-8C6MK4S	X-8JMK4S	X-8PNMK4S	X-8FNMK4S	X-8K46HMB4S
5/8"	5/8"			X-10PNMK4S	X-10FNMK4S	
3/4"	3/4"	X-12C6MK4S	X-12JMK4S	X-12PNMK4S	X-12FNMK4S	X-12K46HMB4S
1"	1"	X-16C6MK4S	X-16JMK4S	X-16PNMK4S	X-16FNMK4S	X-16K46HMB4S
1 1/4"	1 1/4"			X-20PNMK4S	X-20FNMK4S	X-20K46HMB4S
1 1/2"	1 1/2"			X-24PNMK4S	X-24FNMK4S	X-24K46HMB4S
2"	2"			X-32PNMK4S	X-32FNMK4S	X-32K46HMB4S

*BSPP ADAPTORS DO NOT INCLUDE DOWTY SEALS

FOR STAINLESS STEEL—ADD AN EXTRA `S` i.e. X-8 HTX-S => X-8 HTX-SS

STEEL ADAPTORS



BSPT/BSPT



NIPPLE



M/F BUSH



F/M EXPANDER



SOCKET

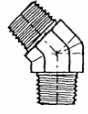

M/M 45DEG
ELBOW

END 1	END 2	Part No.	Part No.	Part No.	Part No.	Part No.
1/8"	1/8"	X-1/8FF33MS			X-1/8GG33MS	
1/4"	1/8"	X-1/4X1/8FF33MS	X-1/4X1/8PTR33MS		X-1/4X1/8GG33MS	
1/4"	1/4"	X-1/4FF33MS		X-1/4FG33MS	X-1/4GG33MS	X-1/4CR4533MS
3/8"	1/8"		X-3/8X1/8PTR33MS			
3/8"	1/4"	X-3/8X1/4FF33MS	X-3/8X1/4PTR33MS	X-3/8X1/4FG33MS	X-3/8X1/4GG33MS	
3/8"	3/8"	X-3/8FF33MS		X-3/8FG33MS	X-3/8GG33MS	X-3/8CR4533MS
1/2"	1/8"		X-1/2X1/8PTR33MS			
1/2"	1/4"	X-1/2X1/4FF33MS	X-1/2X1/4PTR33MS	X-1/2X1/4FG33MS	X-1/2X1/4GG33MS	
1/2"	3/8"	X-1/2X3/8FF33MS	X-1/2X3/8PTR33MS	X-1/2X3/8FG33MS	X-1/2X3/8GG33MS	
1/2"	1/2"	X-1/2FF33MS		X-1/2FG33MS	X-1/2GG33MS	X-1/2CR4533MS
5/8"	1/2"	X-5/8X1/2FF33MS				
5/8"	5/8"	X-5/8FF33MS				
3/4"	1/4"	X-3/4X1/4FF33MS	X-3/4X1/4PTR33MS			
3/4"	3/8"	X-3/4X3/8FF33MS	X-3/4X3/8PTR33MS	X-3/4X3/8FG33MS		
3/4"	1/2"	X-3/4X1/2FF33MS	X-3/4X1/2PTR33MS	X-3/4X1/2FG33MS	X-3/4X1/2GG33MS	
3/4"	5/8"	X-3/4X5/8FF33MS				
3/4"	3/4"	X-3/4FF33MS		X-3/4FG33MS	X-3/4GG33MS	X-3/4CR4533MS
1"	3/8"	X-1X3/8FF33MS	X-1X3/8PTR33MS			
1"	1/2"	X-1X1/2FF33MS	X-1X1/2PTR33MS			
1"	3/4"	X-1X3/4FF33MS	X-1X3/4PTR33MS	X-1X3/4FG33MS	X-1X3/4GG33MS	
1"	1"	X-1FF33MS		X-1FG33MS	X-1GG33MS	X-1CR4533MS
1 1/4"	1/2"		X-1 1/4X1/2PTR33MS			
1 1/4"	3/4"		X-1 1/4X3/4PTR33MS			
1 1/4"	1"	X-1 1/4X1FF33MS	X-1 1/4X1PTR33MS			
1 1/4"	1 1/4"	X-1 1/4FF33MS			X-1 1/4GG33MS	
1 1/2"	3/4"		X-1 1/2X3/4PTR33MS			
1 1/2"	1"	X-1 1/2X1FF33MS	X-1 1/2X1PTR33MS			
1 1/2"	1 1/4"	X-1 1/2X1 1/4FF33MS	X-1 1/2X1 1/4PTR33MS			
1 1/2"	1 1/2"	X-1 1/2FF33MS			X-1 1/2GG33MS	
2"	1 1/4"		X-2X1 1/4PTR33MS			
2"	1 1/2"	X-2X1 1/2FF33MS	X-2X1 1/2PTR33MS			
2"	2"	X-2FF33MS			X-2GG33MS	

FOR STAINLESS STEEL—ADD AN EXTRA `S`

i.e. X-8 HTX-S => X-8 HTX-SS

STEEL ADAPTORS



BSPT/BSPT CONT.

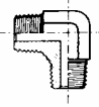

PIPE ELBOW

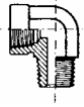

F / M ELBOW

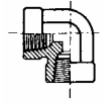

FEMALE ELBOW

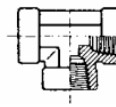

F/F/F TEE

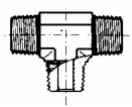

M/M/M TEE

END 1	END 2	Part No.	Part No.	Part No.	Part No.	Part No.
1/8"	1/8"	X-1/8CR33MS	X-1/8CD33MS	X-1/8DD33MS	X-1/8MMO333MS	
1/4"	1/8"	X-1/4X1/8CR33MS				
1/4"	1/4"	X-1/4CR33MS	X-1/4CD33MS	X-1/4DD33MS	X-1/4MMO333MS	X-1/4RRS333MS
3/8"	1/4"	X-3/8X1/4CR33MS				
3/8"	3/8"	X-3/8CR33MS	X-3/8CD33MS	X-3/8DD33MS	X-3/8MMO333MS	X-3/8RRS333MS
1/2"	1/4"	X-1/2X1/4CR33MS				
1/2"	3/8"	X-1/2X3/8CR33MS	X-1/2X3/8CD33MS			
1/2"	1/2"	X-1/2CR33MS	X-1/2CD33MS	X-1/2DD33MS	X-1/2MMO333MS	X-1/2RRS333MS
1/2"	3/4"		X-1/2X3/4CD33MS			
3/4"	3/8"	X-3/4X3/8CR33MS				
3/4"	1/2"	X-3/4X1/2CR33MS	X-3/4X1/2CD33MS			
3/4"	3/4"	X-3/4CR33MS	X-3/4CD33MS	X-3/4DD33MS	X-3/4MMO333MS	X-3/4RRS333MS
1"	3/4"	X-1X3/4CR33MS				
1"	1"	X-1CR33MS	X-1CD33MS	X-1DD33MS	X-1MMO333MS	X-1RRS333MS
1 1/4"	1 1/4"	X-1 1/4CR33MS			X-1 1/4MMO333MS	X-1 1/4RRS333MS
1 1/2"	1 1/2"	X-1 1/2CR33MS				



PLUG



LIFESAVER MALE
WELD ON

END 1	END 2	Part No.	Part No.
1/8"	1/8"	X-1/8HPM3S	
1/4"	1/4"	X-1/4HPM3S	
3/8"	3/8"	X-3/8HPM3S	X-3/8F3HMB4S
1/2"	1/2"	X-1/2HPM3S	X-1/2F3HMB4S
3/4"	3/4"	X-3/4HPM3S	X-3/4F3HMB4S
1"	1"	X-1HPM3S	X-1F3HMB4S
1 1/4"	1 1/4"	X-1 1/4HPM3S	X-1 1/4F3HMB4S
1 1/2"	1 1/2"	X-1 1/2HPM3S	

FOR STAINLESS STEEL—ADD AN EXTRA 'S'

i.e. X-8 HTX-S => X-8 HTX-SS

STEEL ADAPTORS



NPT



NIPPLE



M/F BUSH



F/M EXPANDER



SOCKET

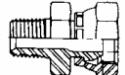

M/F S/W NUT

END 1	END 2	Part No.	Part No.	Part No.	Part No.	Part No.
1/8"	1/8"	X-1/8 FF-S		X-1/8 FG-S	X-1/8 GG-S	X-0107-2-2
1/8"	1/4"					X-0107-2-4
1/4"	1/8"	X-1/4 X 1/8 FF-S	X-1/4 X 1/8 PTR-S	X-1/4 X 1/8 FG-S	X-1/4 X 1/8 GG-S	
1/4"	1/4"	X-1/4 FF-S		X-1/4 FG-S	X-1/4 GG-S	X-0107-4-4
1/4"	3/8"					X-0107-4-6
1/4"	1/2"					X-0107-4-8
3/8"	1/8"	X-3/8 X 1/8 FF-S	X-3/8 X 1/8 PTR-S		X-3/8 X 1/8 GG-S	
3/8"	1/4"	X-3/8 X 1/4 FF-S	X-3/8 X 1/4 PTR-S	X-3/8 X 1/4 FG-S	X-3/8 X 1/4 GG-S	X-0107-6-4
3/8"	3/8"	X-3/8 FF-S		X-3/8 FG-S	X-3/8 GG-S	X-0107-6-6
3/8"	1/2"					X-0107-6-8
1/2"	1/8"		X-1/2 X 1/8 PTR-S	X-1/2 X 1/8 FG-S		
1/2"	1/4"	X-1/2 X 1/4 FF-S	X-1/2 X 1/4 PTR-S	X-1/2 X 1/4 FG-S	X-1/2 X 1/4 GG-S	
1/2"	3/8"	X-1/2 X 3/8 FF-S	X-1/2 X 3/8 PTR-S	X-1/2 X 3/8 FG-S	X-1/2 X 3/8 GG-S	X-0107-8-6
1/2"	1/2"	X-1/2 FF-S		X-1/2 FG-S	X-1/2 GG-S	X-0107-8-8
1/2"	3/4"					X-0107-8-12
3/4"	1/4"		X-3/4 X 1/4 PTR-S	X-3/4 X 1/4 FG-S		
3/4"	3/8"		X-3/4 X 3/8 PTR-S			
3/4"	1/2"	X-3/4 X 1/2 FF-S	X-3/4 X 1/2 PTR-S	X-3/4 X 1/2 FG-S	X-3/4 X 1/2 GG-S	X-0107-12-8
3/4"	3/4"	X-3/4 FF-S			X-3/4 GG-S	X-0107-12-12
3/4"	1"					X-0107-12-16
1"	3/8"		X-1 X 3/8 PTR-S			
1"	1/2"		X-1 X 1/2 PTR-S	X-1 X 1/2 FG-S		
1"	3/4"	X-1 X 3/4 FF-S	X-1 X 3/4 PTR-S	X-1 X 3/4 FG-S		X-0107-16-12
1"	1"	X-1 FF-S			X-1 GG-S	X-0107-16-16
1"	1 1/4"		X-1 1/4 X 3/4 PTR-S			X-0107-16-20
1 1/4"	1"	X-1 1/4 X 1 FF-S	X-1 1/4 X 1 PTR-S			
1 1/4"	1 1/4"	X-1 1/4 FF-S			X-1 1/4 GG-S	X-0107-20-20
1 1/2"	3/4"		X-1 1/2 X 3/4 PTR-S			
1 1/2"	1"		X-1 1/2 X 1 PTR-S			
1 1/2"	1 1/4"		X-1 1/2 X 1 1/4 PTR-S			
1 1/2"	1 1/2"	X-1 1/2 FF-S			X-1 1/2 GG-S	X-0107-24-24
2"	1 1/2"		X-2 X 1 1/2 PTR-S			
2"	2"	X-2 FF-S				X-0107-32-32

FOR STAINLESS STEEL—ADD AN EXTRA `S`

i.e. X-8 HTX-S => X-8 HTX-SS

STEEL ADAPTORS



FLUID HANDLING SOLUTIONS

NPT

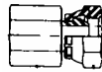

F/F S/w NUT



M/F 45 DEG ELBOW



F/F 45 DEG ELBOW

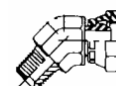

M/F S/W 45DEG

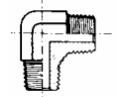

M/M ELBOW

END 1	END 2	Part No.	Part No.	Part No.	Part No.	Part No.
1/8"	1/8"	X-0207-2-2	X-1/8 CD45-S		X-3107-2-2	X-1/8 CR-S
1/4"	1/4"	X-0207-4-4	X-1/4 CD45-S	X-1/4 DD45-S	X-3107-4-4	X-1/4 CR-S
3/8"	1/4"					X-3/8 X 1/4 CR-S
3/8"	3/8"	X-0207-6-6	X-3/8 CD45-S	X-3/8 DD45-S	X-3107-6-6	X-3/8 CR-S
1/2"	3/8"				X-3107-8-6	
1/2"	1/2"	X-0207-8-8	X-1/2 CD45-S	X-1/2 DD45-S	X-3107-8-8	X-1/2 CR-S
3/4"	1/2"				X-3107-12-8	
3/4"	3/4"	X-0207-12-12	X-3/4 CD45-S	X-3/4 DD45-S	X-3107-12-12	X-3/4 CR-S
1"	3/4"				X-3107-16-12	
1"	1"	X-0207-16-16	X-1 CD45-S	X-1 DD45-S	X-3107-16-16	X-1 CR-S
1 1/4"	1 1/4"	X-0207-20-20			X-3107-20-20	



M/F ELBOW

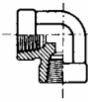

FEMALE ELBOW



F/F 90 DEG ELBOW



M/F 90DEG ELBOW

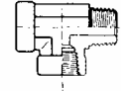

MALE RUN TEE

END 1	END 2	Part No.	Part No.	Part No.	Part No.	Part No.
1/8"	1/8"	X-1/8 CD-S	X-1/8 DD-S	X-2207-2-2	X-2107-2-2	X-1/8 MRO-S
1/4"	1/4"	X-1/4 CD-S	X-1/4 DD-S	X-2207-4-4	X-2107-4-4	X-1/4 MRO-S
1/4"	3/8"				X-2107-4-6	
3/8"	1/4"	X-3/8 X 1/4 CD-S			X-2107-6-4	
3/8"	3/8"	X-3/8 CD-S	X-3/8 DD-S	X-2207-6-6	X-2107-6-6	X-3/8 MRO-S
3/8"	1/2"				X-2107-6-8	
1/2"	3/8"				X-2107-8-6	
1/2"	1/2"	X-1/2 CD-S	X-1/2 DD-S	X-2207-8-8	X-2107-8-8	X-1/2 MRO-S
1/2"	3/4"				X-2107-8-12	
3/4"	3/8"				X-2107-12-6	
3/4"	1/2"				X-2107-12-8	
3/4"	3/4"	X-3/4 CD-S	X-3/4 DD-S	X-2207-12-12	X-2107-12-12	X-3/4 MRO-S
1"	3/4"				X-2107-16-12	
1"	1"	X-1 CD-S	X-1 DD-S	X-2207-16-16	X-2107-16-16	X-1 MRO-S
1 1/4"	1 1/4"	X-1 1/4 CD-S	X-1 1/4 DD-S	X-2207-20-20	X-2107-20-20	

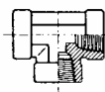

FEMALE TEE



MLE BRANCH TEE



FEMALE CROSS



HEX PLUG

END 1	END 2	Part No.	Part No.	Part No.	Part No.
1/8"	1/8"	X-1/8 MMO-S	X-1/8 MMS-S	X-1/8 KMMOO-S	X-1/8 HP-S
1/4"	1/4"	X-1/4 MMO-S	X-1/4 MMS-S	X-1/4 KMMOO-S	X-1/4 HP-S
3/8"	3/8"	X-3/8 MMO-S	X-3/8 MMS-S	X-3/8 KMMOO-S	X-3/8 HP-S
1/2"	1/2"	X-1/2 MMO-S	X-1/2 MMS-S	X-1/2 KMMOO-S	X-1/2 HP-S
3/4"	3/4"	X-3/4 MMO-S	X-3/4 MMS-S	X-3/4 KMMOO-S	X-3/4 HP-S
1"	1"	X-1 MMO-S	X-1 MMS-S	X-1 KMMOO-S	X-1 HP-S
1 1/4"	1 1/4"	X-1 1/4 MMO-S			X-1 1/4 HP-S

FOR STAINLESS STEEL—ADD AN EXTRA 'S' i.e. X-8 HTX-S => X-8 HTX-SS

STEEL ADAPTORS



JIC

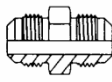

NIPPLE

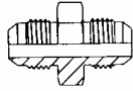

NIPPLE—LARGE HEX

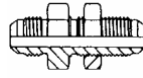

BULKHEAD
(C/W LOCKNUT)



EXPANDER



TUBE END RED.
(NUT NOT INCLUDED
SEE BTX)

END 1	END 2	Part No.	Part No.	Part No.	Part No.	Part No.
5/16"	5/16"	X-2 HTX-S				
3/8"	3/8"	X-3 HTX-S		X-3 WTX-WLN-S		
7/16"	7/16"	X-4 HTX-S	X-4 LHTX-S	X-4 WTX-WLN-S	X-4 XHX6-S	
1/2"	7/16"	X-5-4 HTX-S				
1/2"	1/2"	X-5 HTX-S	X-5 LHTX-S	X-5 WTX-WLN-S		
9/16"	7/16"	X-6-4 HTX-S				X-6-4 TRTX-S
9/16"	1/2"	X-6-5 HTX-S				X-6-5 TRTX-S
9/16"	9/16"	X-6 HTX-S	X-6 LHTX-S	X-6 WTX-WLN-S	X-6 XHX6-S	
3/4"	7/16"					X-8-4 TRTX-S
3/4"	9/16"	X-8-6 HTX-S				X-8-6 TRTX-S
3/4"	3/4"	X-8 HTX-S	X-8 LHTX-S	X-8 WTX-WLN-S	X-8 XHX6-S	
7/8"	7/16"					X-10-4 TRTX-S
7/8"	9/16"					X-10-6 TRTX-S
7/8"	3/4"	X-10-8 HTX-S				X-10-8 TRTXN-S
7/8"	7/8"	X-10 HTX-S	X-10 LHTX-S	X-10 WTX-WLN-S	X-10 XHX6-S	
1 1/16"	7/16"					X-12-4 TRTX-S
1 1/16"	9/16"	X-12-6 HTX-S				X-12-6 TRTX-S
1 1/16"	3/4"	X-12-8 HTX-S				X-12-8 TRTX-S
1 1/16"	7/8"	X-12-10 HTX-S				X-12-10 TRTXN-S
1 1/16"	1 1/16"	X-12 HTX-S	X-12 LHTX-S	X-12 WTX-WLN-S	X-12 XHX6-S	
1 3/16"	9/16"					X-14-6 TRTX-S
1 3/16"	7/8"					X-14-10 TRTX-S
1 3/16"	1 1/16"					X-14-12 TRTXN-S
1 3/16"	1 3/16"	X-14 HTX-S		X-14 WTX-WLN-S		
1 5/16"	3/4"					X-16-8 TRTX-S
1 5/16"	7/8"	X-16-10 HTX-S				
1 5/16"	1 1/16"	X-16-12 HTX-S				X-16-12 TRTX-S
1 5/16"	1 3/16"					X-16-14 TRTXN-S
1 5/16"	1 5/16"	X-16 HTX-S	X-16 LHTX-S	X-16 WTX-WLN-S		
1 5/8"	1 1/16"					X-20-12 TRTX-S
1 5/8"	1 5/16"	X-20-16 HTX-S				X-20-16 TRTX-S
1 5/8"	1 5/8"	X-20 HTX-S		X-20 WTX-WLN-S		
1 7/8"	1 5/8"					X-24-20 TRTX-S
1 7/8"	1 7/8"	X-24 HTX-S		X-24 WTX-WLN-S		
2 1/2"	2 1/2"	X-32 HTX-S				

FOR STAINLESS STEEL—ADD AN EXTRA `S' i.e. X-8 HTX-S => X-8 HTX-SS

STEEL ADAPTORS



JIC

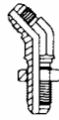

BULKHEAD UNION
45 DEG ELBOW
(INCLUDES LOCKNUT)



M/F S/W NUT 45DEG
ELBOW

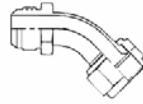

M/F S/W NUT 45DEG TUBE
ADAPTOR

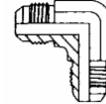

UNION ELBOW

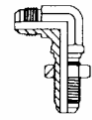

BULKHEAD UNION
ELBOW
(INCLUDES LOCKNUT)

END 1	END 2	Part No.	Part No.	Part No.	Part No.	Part No.
5/16"	5/16"				X-2 ETX-S	
7/16"	7/16"	X-4 WNTX-WLN-S	X-4 V6X-S		X-4 ETX-S	X-4 WETX-WLN-S
1/2"	1/2"	X-5 NTX-WLN-S	X-5 V6X-S		X-5 ETX-S	X-5 WETX-WLN-S
9/16"	9/16"	X-6 WNTX-WLN-S	X-6 V6X-S	X-37T3-6-6	X-6 ETX-S	X-6 WETX-WLN-S
3/4"	9/16"				X-8-6 ETX-S	
3/4"	3/4"	X-8 WNTX-WLN-S	X-8 V6X-S	X-37T3-8-8	X-8 ETX-S	X-8 WETX-WLN-S
7/8"	3/4"				X-10-8 ETX-S	
7/8"	7/8"	X-10 WNTX-WLN-S	X-10 V6X-S	X-37T3-10-10	X-10 ETX-S	X-10 WETX-WLN-S
1 1/16"	1 1/16"	X-12 WNTX-WLN-S	X-12 V6X-S	X-37T3-12-12	X-12 ETX-S	X-12 WETX-WLN-S
1 3/16"	1 3/16"		X-14 V6X-S		14 ETX-S	X-14 WETX-WLN-S
1 5/16"	1 5/16"	X-16 WNTX-WLN-S	X-16 V6X-S	X-37T3-16-16	16 ETX-S	X-16 WETX-WLN-S
1 5/8"	1 5/8"		X-20 V6X-S	X-37T3-20-20	20 ETX-S	X-20 WETX-WLN-S
1 7/8"	1 7/8"		X-24 V6X-S		24 ETX-S	
2 1/2"	2 1/2"				32 ETX-S	



M/ F S/W NUT
ELBOW

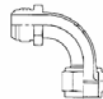

M/F S/W NUT 90DEG
TUBE ELBOW

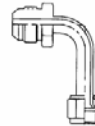

M/F S/W NUT 90DEG LONG
TUBE ELBOW

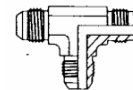

UNION TEE

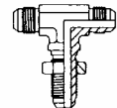

BULKHEAD UNION TEE

END 1	END 2	Part No.	Part No.	Part No.	Part No.	Part No.
5/16"	5/16"				X-2 JTX-S	
3/8"	3/8"				X-3 JTX-S	
7/16"	7/16"	X-4 C6X-S	X-39T3-4-4	X-41T3-4-4	X-4 JTX-S	X-4 WJTX-WLN-S
1/2"	1/2"	X-5 C6X-S			X-5 JTX-S	
9/16"	9/16"	X-6 C6X-S	X-39T3-6-6	X-41T3-6-6	X-6 JTX-S	X-6 WJTX-WLN-S
3/4"	3/4"	X-8 C6X-S	X-39T3-8-8	X-41T3-8-8	X-8 JTX-S	X-8 WJTX-WLN-S
3/4"	7/8"	X-8-10 C6X-S				
7/8"	7/8"	X-10 C6X-S	X-39T3-10-10	X-41T3-10-10	X-10 JTX-S	X-10 WJTX-WLN-S
7/8"	1 1/16"	X-10-12 C6X-S				
1 1/16"	3/4"	X-12-8 C6X-S				
1 1/16"	7/8"	X-12-10 C6X-S				
1 1/16"	1 1/16"	X-12 C6X-S	X-39T3-12-12	X-41T3-12-12	X-12 JTX-S	X-12 WJTX-WLN-S
1 3/16"	1 3/16"	X-14 C6X-S			X-14 JTX-S	
1 5/16"	1 5/16"	X-16 C6X-S	X-39T3-16-16	X-41T3-16-16	X-16 JTX-S	
1 5/8"	1 5/8"	X-20 C6X-S	X-39T3-20-20	X-41T3-20-20	X-20 JTX-S	
1 7/8"	1 7/8"	X-24 C6X-S			X-24 JTX-S	

FOR STAINLESS STEEL—ADD AN EXTRA `S` i.e. X-8 HTX-S => X-8 HTX-SS

STEEL ADAPTORS



JIC

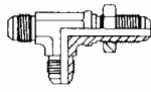

BULKHEAD RUN TEE

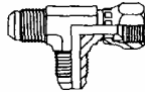

FEMALE S/w NUT RUN TEE

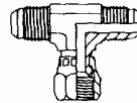

FEMALE S/w NUT BRANCH TEE

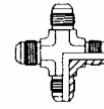

UNION CROSS



MALE LIFESAVER WELD ON

END 1	END 2	Part No.	Part No.	Part No.	Part No.	Part No.
7/16"	7/16"	X-4 WJTX-WLN-S	X-4 R6X-S	X-4 S6X-S	X-4 KTX-S	X-4XHB4S
1/2"	1/2"		X-5 R6X-S	X-5 S6X-S	X-5 KTX-S	
9/16"	9/16"	X-6 WJTX-WLN-S	X-6 R6X-S	X-6 S6X-S	X-6 KTX-S	X-6XHB4S
3/4"	3/4"	X-8 WJTX-WLN-S	X-8 R6X-S	X-8 S6X-S	X-8 KTX-S	X-8XHB4S
7/8"	7/8"	X-10 WJTX-WLN-S	X-10 R6X-S	X-10 S6X-S	X-10 KTX-S	X-10XHB4S
1 1/16"	1 1/16"	X-12 WJTX-WLN-S	X-12 R6X-S	X-12 S6X-S	X-12 KTX-S	X-12XHB4S
1 3/16"	1 3/16"		X-14 R6X-S	X-14 S6X-S		
1 5/16"	1 5/16"		X-16 R6X-S	X-16 S6X-S		X-16XHB4S
1 5/8"	1 5/8"		X-20 R6X-S	X-20 S6X-S		X-20XHB4S
1 7/8"	1 7/8"		X-24 R6X-S			X-24XHB4S



FEMALE S/w NUT LIFESAVER WELD ON



PLUG



CAP

END 1	END 2	Part No.	Part No.	Part No.
5/16"	5/16"			X-2 FNTX-S
3/8"	3/8"		X-3 PNTX-S	X-3 FNTX-S
7/16"	7/16"	X-4XHB4S	X-4 PNTX-S	X-4 FNTX-S
1/2"	7/16"		X-5 PNTX-S	X-5 FNTX-S
9/16"	9/16"	X-6XHB4S	X-6 PNTX-S	X-6 FNTX-S
3/4"	3/4"	X-8XHB4S	X-8 PNTX-S	X-8 FNTX-S
7/8"	3/4"	X-10-8X6HB4S		
7/8"	7/8"	X-10X6HB4S	X-10 PNTX-S	X-10 FNTX-S
7/8"	1 1/16"	X-10-12X6HB4S		
1 1/16"	1 1/16"	X-12X6HB4S	X-12 PNTX-S	X-12 FNTX-S
1 3/16"	1 3/16"		X-14 PNTX-S	X-14 FNTX-S
1 5/16"	1 5/16"	X-16X6HB4S	X-16 PNTX-S	X-16 FNTX-S
1 5/8"	1 5/8"	X-20X6HB4S	X-20 PNTX-S	X-20 FNTX-S
1 5/8"	1 7/8"	X-20-24X6HB4S		
1 7/8"	1 7/8"		X-24 PNTX-S	X-24 FNTX-S
2 1/2"	2 1/2"	X-32X6HB4S	X-32 PNTX-S	X-32 FNTX-S

SAE

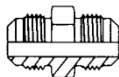

NIPPLE



PLUG



CAP

END 1	END 2	Part No.	Part No	Part No
5/8"	5/8"	X-6 HS-S	X-6 PNS-S	X-6 FNS-S

FOR STAINLESS STEEL—ADD AN EXTRA `S` i.e. X-8 HTX-S => X-8 HTX-SS

STEEL ADAPTORS



JIC FLARE NUT & SLEEVES

THE TUBE NEEDS TO BE FLARED FOR USE WITH BTX & TX NUTS.

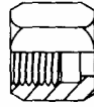

TUBE NUT



SLEEVE
(IMPERIAL)



SLEEVE
(METRIC)

THREAD SIZE	TUBE SIZE (IMPERIAL)	Part No.	Part No.	TUBE SIZE METRIC	USE TUBE NUT	Part No
5/16"	1/8"	X-2 BTX-S	X-2 TX-S	6MM	X-4 BTX-S	X-TXS6
3/8"	3/16"	X-3 BTX-S	X-3 TX-S	8MM	X-5 BTX-S	X-5 TX-S
7/16"	1/4"	X-4 BTX-S	X-4 TX-S	10MM	X-6 BTX-S	X-TXS10
1/2"	5/16"	X-5 BTX-S	X-5 TX-S	12MM	X-8 BTX-S	X-TXS12
9/16"	3/8"	X-6 BTX-S	X-6 TX-S	14MM	X-10 BTX-S	X-TXS14
3/4"	1/2"	X-8 BTX-S	X-8 TX-S	15MM	X-10 BTX-S	X-TXS15
7/8"	5/8"	X-10 BTX-S	X-10 TX-S	16MM	X-10 BTX-S	X-10 TX-S
1 1/16"	3/4"	X-12 BTX-S	X-12 TX-S	18MM	X-12 BTX-S	X-TXS18
1 1/16"	-	X-20-12 BTX-S		20MM	X-20-12 BTX-S	X-20-12 TX-S
1 3/16"	7/8"	X-14 BTX-S	X-14 TX-S	22MM	X-14 BTX-S	X-TXS22
1 5/16"	1"	X-16 BTX-S	X-16 TX-S	25MM	X-16 BTX-S	X-TXS25
1 5/8"	1 1/4"	X-20 BTX-S	X-20 TX-S	28MM	X-20 BTX-S	X-TXS28
1 7/8"	1 1/2"	X-24 BTX-S	X-24 TX-S	30MM	X-20 BTX-S	X-TXS30
2 1/2"	2"	X-32 BTX-S	X-32 TX-S	32MM	X-20 BTX-S	X-TXS32
				35MM	X-24 BTX-S	X-TXS35
				38MM	X-24 BTX-S	X-24 TX-S

JIC—FLARELESS NUT & SLEEVE

THERE IS NO REQUIREMENT TO FLARE TUBE WHEN USING ZL0 NUT & SLEEVE

THREAD	TUBE	Part No.
7/16"	3/8"	X-ZL0106
3/4"	1/2"	X-ZL0108
7/8"	5/8"	X-ZL0110
1 1/16"	3/4"	X-ZL0112
1 3/16"	7/8"	X-ZL0114
1 5/16"	1"	X-ZL0116

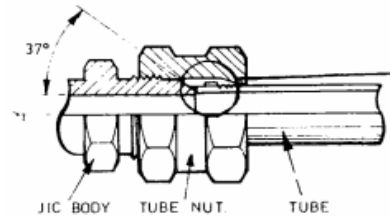

JIS / BSPT ADAPTORS 30 DEG FLARE

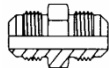

JIS UNION 30°



Male BSPT x JIS 30°



BSPT x JIS 30° Elbow



BSPT x JIS Internal 30°



BSPT X JIS (Internal)
ELBOW

END 1	END 2	Part No.	Part No.	Part No.	Part No.	Part No.
1/4"	1/4"	X-4HMT4S	X-4F3T4S	X-4C3T4S	X-4F3P4S	X-4C3P4S
1/4"	3/8"		X-4-6F3T4S			
3/8"	1/4"		X-6-4F3T4S			
3/8"	3/8"	X-6HMT4S	X-6F3T4S	X-6C3T4S	X-6F3P4S	X-6C3P4S
1/2"	3/8"		X-8-6F3T4S			
1/2"	1/2"	X-8HMT4S	X-8F3T4S	X-8C3T4S	X-8F3P4S	X-8C3P4S
3/4"	3/4"	X-12HMT4S	X-12F3T4S	X-12C3T4S	X-12F3P4S	X-12C3P4S
1"	1"	X-16HMT4S	X-16F3T4S	X-16C3T4S	X-16F3P4S	X-16C3P4S

FOR STAINLESS STEEL—ADD AN EXTRA 'S' i.e. X-8 HTX-S => X-8 HTX-SS

STEEL ADAPTORS



UN O-RING



NIPPLE



EXPANDER



M/F ELBOW

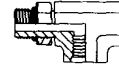

RUN TEE

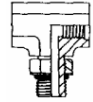

BRANCH TEE

END 1	END 2	Part No.	Part No.	Part No.	Part No.	Part No.
7/16"	7/16"	X-4 F5OHAO-S		X-4 AOEG5-S	X-4 AOG5JG5-S	X-4 G5G5JAO-S
3/4"	9/16"		X-4-6 F5OG5-S			
9/16"	7/16"		X-6-4 F5OG5-S			
9/16"	9/16"	X-6 F5OHAO-S		X-6 AOEG5-S	X-6 AOG5JG5-S	X-6 G5G5JAO-S
9/16"	3/4"		X-6-8 F5OG5-S			
3/4"	9/16"		X-8-6 F5OG5-S			
3/4"	3/4"	X-8 F5OHAO-S		X-8 AOEG5-S	X-8 AOG5JG5-S	X-8 G5G5JAO-S
3/4"	7/8"		X-8-10 F5OG5-S			
7/8"	9/16"		X-10-6 F5OG5-S			
7/8"	3/4"		X-10-8 F5OG5-S			
7/8"	7/8"	X-10 F5OHAO-S		X-10 AOEG5-S	X-10 AOG5JG5-S	X-10 G5G5JAO-S
7/8"	1 1/16"		X-10-12 F5OG5-S			
1 1/16"	3/4"		X-12-8 F5OG5-S			
1 1/16"	7/8"		X-12-10 F5OG5-S			
1 1/16"	1 1/16"	X-12 F5OHAO-S		X-12 AOEG5-S	X-12 AOG5JG5-S	X-12 G5G5JAO-S
1 5/16"	3/4"		X-16-8 F5OG5-S			
1 5/16"	1 1/16"		X-16-12 F5OG5-S			
1 5/16"	1 5/16"	X-16 F5OHAO-S		X-16 AOEG5-S	X-16 AOG5JG5-S	X-16 G5G5JAO-S
1 5/8"	1 1/16"		X-20-12 F5OG5-S			
1 5/8"	1 5/16"		X-20-16 F5OG5-S			
1 5/8"	1 5/8"	X-20 F5OHAO-S				
1 7/8"	1 1/16"		X-24-12 F5OG5-S			
1 7/8"	1 5/16"		X-24-16 F5OG5-S			
1 7/8"	1 7/8"	X-24 F5OHAO-S				
1 7/8"	1 5/8"		X-24-20 F5OG5-S			
2 1/2"	2 1/2"	X-32 F5OHAO-S				

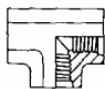

FEM /FEM /FEM TEE



PLUG



ALLEN KEY PLUG

END 1	END 2	Part No.	Part No.	Part No.
5/16"	5/16"		X-2 P5ON-S	X-2 HP5ON-S
3/8"	3/8"		X-3 P5ON-S	X-3 HP5ON-S
7/16"	7/16"	X-4 G5G5JG5-S	X-4 P5ON-S	X-4 HP5ON-S
1/2"	1/2"		X-5 P5ON-S	X-5 HP5ON-S
9/16"	9/16"	X-6 G5G5JG5-S	X-6 P5ON-S	X-6 HP5ON-S
3/4"	3/4"	X-8 G5G5JG5-S	X-8 P5ON-S	X-8 HP5ON-S
7/8"	7/8"	X-10 G5G5JG5-S	X-10 P5ON-S	X-10 HP5ON-S
1 1/16"	1 1/16"	X-12 G5G5JG5-S	X-12 P5ON-S	X-12 HP5ON-S
1 3/16"	1 3/16"		X-14 P5ON-S	X-14 HP5ON-S
1 5/16"	1 5/16"	X-16 G5G5JG5-S	X-16 P5ON-S	X-16 HP5ON-S
1 5/8"	1 5/8"		X-20 P5ON-S	X-20 HP5ON-S
1 7/8"	1 7/8"		X-24 P5ON-S	X-24 HP5ON-S
2 1/2"	2 1/2"		X-32 P5ON-S	

FOR STAINLESS STEEL—ADD AN EXTRA `S` *i.e. X-8 HTX-S => X-8 HTX-SS*

STEEL ADAPTORS



ORFS



NIPPLE



BULK HEAD UNION

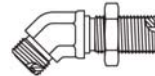

BULK HEAD UNION 45DEG



UNION ELBOW 90DEG

ORFS	ORFS	Part No.	Part No.	Part No.	Part No.
9/16"	9/16"	X-4 HLO-S	X-4 WLO-WLNL-S	X-4 WNLO-WLNL-S	X-4 ELO-S
11/16"	9/16"	X-6-4 HLO-S			
11/16"	11/16"	X-6 HLO-S	X-6 WLO-WLNL-S	X-6 WNLO-WLNL-S	X-6 ELO-S
13/16"	11/16"	X-8-6 HLO-S			
13/16"	13/16"	X-8 HLO-S	X-8 WLO-WLNL-S	X-8 WNLO-WLNL-S	X-8 ELO-S
1"	13/16"	X-10-8 HLO-S			
1"	1"	X-10 HLO-S	X-10 WLO-WLNL-S	X-10 WNLO-WLNL-S	X-10 ELO-S
1 3/16"	1"	X-12-10 HLO-S			
1 3/16"	1 3/16"	X-12 HLO-S	X-12 WLO-WLNL-S	X-12 WNLO-WLNL-S	X-12 ELO-S
1 7/16"	1 3/16"	X-16-12 HLO-S			
1 7/16"	1 7/16"	X-16 HLO-S	X-16 WLO-WLNL-S	X-16 WNLO-WLNL-S	X-16 ELO-S
1 11/16"	1 11/16"	X-20 HLO-S	X-20 WLO-WLNL-S	X-20 WNLO-WLNL-S	X-20 ELO-S
2"	2"	X-24 HLO-S	X-24 WLO-WLNL-S	X-24 WNLO-WLNL-S	X-24 ELO-S

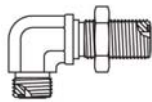

90DEG BULKHEAD



M/F 90DEG EL-BOW

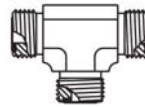

UNION TEE



BRANCH TEE



RUN TEE

ORFS	ORFS	Part No.	Part No.	Part No.	Part No.	Part No.
9/16"	9/16"	X-4 WELO-WLNL-S	X-4 C6LO-S	X-4 JLO-S	X-4 S6LO-S	X-4 R6LO-S
11/16"	11/16"	X-6 WELO-WLNL-S	X-6 C6LO-S	X-6 JLO-S	X-6 S6LO-S	X-6 R6LO-S
13/16"	13/16"	X-8 WELO-WLNL-S	X-8 C6LO-S	X-8 JLO-S	X-8 S6LO-S	X-8 R6LO-S
1"	1"	X-10 WELO-WLNL-S	X-10 C6LO-S	X-10 JLO-S	X-10 S6LO-S	X-10 R6LO-S
1 3/16"	1 3/16"	X-12 WELO-WLNL-S	X-12 C6LO-S	X-12 JLO-S	X-12 S6LO-S	X-12 R6LO-S
1 7/16"	1 7/16"	X-16 WELO-WLNL-S	X-16 C6LO-S	X-16 JLO-S	X-16 S6LO-S	X-16 R6LO-S
1 11/16"	1 11/16"	X-20 WELO-WLNL-S	X-20 C6LO-S	X-20 JLO-S	X-20 S6LO-S	X-20 R6LO-S
2"	2"	X-24 WELO-WLNL-S	X-24 C6LO-S	X-24 JLO-S	X-24 S6LO-S	X-24 R6LO-S

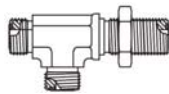

BULK HEAD RUN TEE

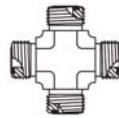

CROSS



CAP



PLUG

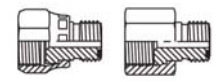

TUBE END REDUCER
FEM / MALE

ORFS	ORFS	Part No.	Part No.	Part No.	Part No.	Part No.
9/16"	9/16"	X-4 WJLO-WLNL-S	X-4 KLO-S	X-4 FNL-S	X-4 PNLO-S	
11/16"	9/16"					X-6-4 TRLON-S
11/16"	11/16"	X-6 WJLO-WLNL-S	X-6 KLO-S	X-6 FNL-S	X-6 PNLO-S	
13/16"	13/16"	X-8 WJLO-WLNL-S	X-8 KLO-S	X-8 FNL-S	X-8 PNLO-S	
13/16"	11/16"					X-8-6 TRLON-S
1"	1"	X-10 WJLO-WLNL-S	X-10 KLO-S	X-10 FNL-S	X-10 PNLO-S	
1 3/16"	1"					X-12-10 TRLON-S
1 3/16"	1 3/16"	X-12 WJLO-WLNL-S	X-12 KLO-S	X-12 FNL-S	X-12 PNLO-S	
1 7/16"	1 3/16"					X-16-12 TRLON-S
1 7/16"	1 7/16"	X-16 WJLO-WLNL-S	X-16 KLO-S	X-16 FNL-S	X-16 PNLO-S	
1 11/16"	1 7/16"					X-20-16 TRLON-S
1 11/16"	1 11/16"	X-20 WJLO-WLNL-S	X-20 KLO-S	X-20 FNL-S	X-20 PNLO-S	
2"	2"	X-24 WJLO-WLNL-S		X-24 FNL-S	X-24 PNLO-S	

FOR STAINLESS STEEL—ADD AN EXTRA `S`

i.e. X-8 HTX-S => X-8 HTX-SS

STEEL CONVERSION ADAPTORS



JIC / BSPT



NIPPLE



JIC FEM X BSPT MALE

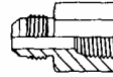

JIC X BSPT

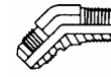

JIC X BSPT 45°

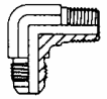

JIC X BSPT 90°

JIC	BSPT	Part No.	Part No.	Part No.	Part No.	Part No.
7/16"	1/8"	X-4F3MXS	X-4F63MXS		X-4V3MXS	X-4C3MXS
7/16"	1/4"	X-4-4F3MXS	X-4-4F63MXS		X-4-4V3MXS	X-4-4C3MXS
7/16"	3/8"	X-4-6F3MXS				X-4-6C3MXS
7/16"	1/2"	X-4-8F3MXS				X-4-8C3MXS
1/2"	1/8"	X-5F3MXS				X-5C3MXS
1/2"	1/4"	X-5-4F3MXS			X-5-4V3MXS	X-5-4C3MXS
1/2"	3/8"	X-5-6F3MXS				
1/2"	1/2"	X-5-8F3MXS				
9/16"	1/8"	X-6-2F3MXS				X-6-2C3MXS
9/16"	1/4"	X-6F3MXS	X-6F63MXS	X-6G3MXS	X-6V3MXS	X-6C3MXS
9/16"	3/8"	X-6-6F3MXS	X-6-6F63MXS	X-6-6G3MXS	X-6-6V3MXS	X-6-6C3MXS
9/16"	1/2"	X-6-8F3MXS				X-6-8C3MXS
9/16"	3/4"	X-6-12F3MXS				X-6-12C3MXS
3/4"	1/4"	X-8-4F3MXS	X-8-4F63MXS			X-8-4C3MXS
3/4"	3/8"	X-8F3MXS	X-8F63MXS		X-8V3MXS	X-8C3MXS
3/4"	1/2"	X-8-8F3MXS	X-8-8F63MXS	X-8-8G3MXS	X-8-8V3MXS	X-8-8C3MXS
3/4"	3/4"	X-8-12F3MXS				X-8-12C3MXS
3/4"	1"	X-8-16F3MXS				
7/8"	3/8"	X-10-6F3MXS			X-10-6V3MXS	X-10-6C3MXS
7/8"	1/2"	X-10F3MXS	X-10F63MXS	X-10G3MXS	X-10V3MXS	X-10C3MXS
7/8"	3/4"	X-10-12F3MXS			X-10-12V3MXS	X-10-12C3MXS
7/8"	1"	X-10-16F3MXS				
1 1/16"	3/8"	X-12-6F3MXS				
1 1/16"	1/2"	X-12-8F3MXS	X-12-8F63MXS		X-12-8V3MXS	X-12-8C3MXS
1 1/16"	3/4"	X-12F3MXS	X-12F63MXS	X-12G3MXS	X-12V3MXS	X-12C3MXS
1 1/16"	1"	X-12-16F3MXS				X-12-16C3MXS
1 1/16"	1 1/2"	X-12-20F3MXS				
1 3/16"	3/4"	X-14F3MXS				
1 3/16"	1"	X-14-16F3MXS				
1 5/16"	3/4"	X-16-12F3MXS	X-16-12F63MXS			X-16-12C3MXS
1 5/16"	1"	X-16F3MXS	X-16F63MXS	X-16G3MXS	X-16V3MXS	X-16C3MXS
1 5/16"	1 1/4"	X-16-20F3MXS				
1 5/16"	1 1/2"	X-16-24F3MXS				
1 5/8"	1"	X-20-16F3MXS				X-20-16C3MXS
1 5/8"	1 1/4"	X-20F3MXS	X-20F63MXS			X-20C3MXS
1 5/8"	1 1/2"	X-20-24F3MXS				
1 7/8"	1 1/2"	X-24F3MXS				X-24C3MXS
2 1/2"	2"	X-32F3MXS				

FOR STAINLESS STEEL—ADD AN EXTRA `S' i.e. X-8 HTX-S => X-8 HTX-SS

STEEL CONVERSION ADAPTORS



JIC / BSPT

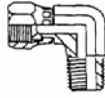

BSPT X JIC

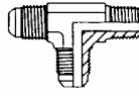

BSPT X JIC BSP MALE RUN
TEE

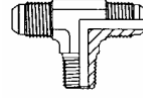

BSPT X JIC BRANCH TEE

JIC	BSPT	Part No.	Part No.	Part No.
7/16"	1/8"		X-4R3MXS	X-4S3MXS
7/16"	1/4"	X-4-4C63MXS		X-4-4-4S3MXS
9/16"	1/4"	X-6C63MXS	X-6R3MXS	X-6S3MXS
9/16"	3/8"	X-6-6C63MXS	X-6-6-6R3MXS	X-6-6-6S3MXS
3/4"	3/8"		X-8R3MXS	X-8S3MXS
3/4"	1/2"	X-8-8C63MXS	X-8-8-8R3MXS	X-8-8-8S3MXS
7/8"	1/2"		X-10R3MXS	X-10S3MXS
1 1/16"	3/4"	X-12C63MXS	X-12R3MXS	X-12S3MXS
1 1/16"	1"		X-12-16-12R3MXS	
1 5/16"	1"	X-16C63MXS	X-16R3MXS	

JIC / BSPP

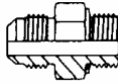

JIC M X BSPP M

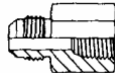

JIC M X BSPP F



JIC M X BSPP F



JIC F X BSPP M



JIC M X BSPP M

JIC	BSPP*	Part No.	Part No.	Part No.	Part No.	Part No.
7/16"	1/8"	X-4F4OMXS			X-4F64OMXS	X-4V4OMXS
7/16"	1/4"	X-4-4F4OMXS	X-4-4G4MXS		X-4-4F64OMXS	
7/16"	3/8"	X-4-6F4OMXS				
7/16"	1/2"	X-4-8F4OMXS				
1/2"	1/8"	X-5F4OMXS	X-5G4MXS			
1/2"	1/4"	X-5-4F4OMXS			X-5-4F64OMXS	
1/2"	3/8"	X-5-6F4OMXS				
9/16"	1/8"	X-6-2F4OMXS				
9/16"	1/4"	X-6F4OMXS	X-6G4MXS	X-6-4XHMK46S	X-6F64OMXS	X-6V4OMXS
9/16"	3/8"	X-6-6F4OMXS	X-6-6G4MXS	X-6XHMK46S	X-6-6F64OMXS	
9/16"	1/2"	X-6-8F4OMXS				
9/16"	3/4"	X-6-12F4OMXS				
3/4"	1/4"	X-8-4F4OMXS				
3/4"	3/8"	X-8F4OMXS	X-8G4MXS		X-8F64OMXS	X-8V4OMXS
3/4"	1/2"	X-8-8F4OMXS	X-8-8G4MXS	X-8XHMK46S	X-8-8F64OMXS	
3/4"	5/8"	X-8-10F4OMXS				
3/4"	3/4"	X-8-12F4OMXS				
7/8"	3/8"	X-10-6F4OMXS			X-10-6F64OMXS	
7/8"	1/2"	X-10F4OMXS	X-10G4MXS		X-10F64OMXS	X-10V4OMXS
7/8"	3/4"	X-10-12F4OMXS				
1 1/16"	3/8"	X-12-6F4OMXS				
1 1/16"	1/2"	X-12-8F4OMXS			X-12-8F64OMXS	
1 1/16"	3/4"	X-12F4OMXS	X-12G4MXS	X-12XHMK46S	X-12F64OMXS	X-12V4OMXS
1 1/16"	1"	X-12-16F4OMXS				
1 5/16"	3/4"	X-16-12F4OMXS				
1 5/16"	1"	X-16F4OMXS	X-16G4MXS	X-16XHMK46S	X-16F64OMXS	X-16V4OMXS
1 5/16"	1 1/4"	X-16-20F4OMXS				
1 5/8"	1"	X-20-16F4OMXS				
1 5/8"	1 1/4"	X-20F4OMXS			X-20F64OMXS	
1 5/8"	1 1/2"	X-20-24F4OMXS				
1 7/8"	1 1/2"	X-24F4OMXS			X-24F64OMXS	
1 7/8"	1 1/4"	X-24-20F4OMXS				

* DOES NOT INCLUDE DOWTY SEAL

FOR STAINLESS STEEL—ADD AN EXTRA `S` i.e. X-8 HTX-S => X-8 HTX-SS

STEEL CONVERSION ADAPTORS



JIC / BSPP*

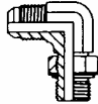

ELBOW

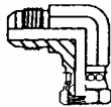

MALE JIC X BSPP FEMALE ELBOW

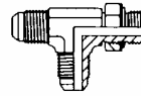

JIC x JIC x BSPP RUN TEE

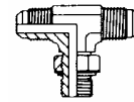

JIC x BSPP x JIC BRANCH TEE

JIC	BSPP*	Part No.	Part No.	Part No.	Part No.
7/16"	1/8"	X-4C4OMXS			
7/16"	1/4"	X-4-4C4OMXS			
1/2"	1/4"	X-5-4C4OMXS			
9/16"	1/4"	X-6C4OMXS		X-6R4OMXS	X-6S4OMXS
9/16"	3/8"	X-6-6C4OMXS	X-6XEMK46S		
9/16"	1/2"	X-6-8C4OMXS			
3/4"	1/4"	X-8-4C4OMXS			
3/4"	3/8"	X-8C4OMXS	X-8-6XEMK46S	X-8R4OMXS	X-8S4OMXS
3/4"	1/2"	X-8-8C4OMXS	X-8XEMK46S		X-8-8-8S4OMXS
3/4"	3/4"	X-8-12C4OMXS			
7/8"	3/8"	X-10-6C4OMXS			
7/8"	1/2"	X-10-4C4OMXS	X-10-8XEMK46S	X-10R4OMXS	X-10S4OMXS
7/8"	3/4"	X-10-12C4OMXS			
1 1/15"	1/2"	X-12-8C4OMXS			
1 1/15"	3/4"	X-12C4OMXS		X-12R4OMXS	X-12S4OMXS
1 1/15"	1"	X-12-16C4OMXS			
1 5/16"	3/4"	X-16-12C4OMXS			
1 5/16"	1"	X-16C4OMXS			
1 5/16"	1 1/4"	X-16-20C4OMXS			
1 5/8"	1"	X-20-16C4OMXS			
1 5/8"	1 1/4"	X-20C4OMXS			
1 7/8"	1 1/2"	X-24C4OMXS			

* DOES NOT INCLUDE DOWTY SEAL

SAE / BSPT



NIPPLE

SAE	BSPT	Part No.
5/8"	1/4"	X-6-4SMF3S
5/8"	3/8"	X-6-6SMF3S
3/4"	5/8"	X-8-10SMF3S
3/4"	3/4"	X-8-12SMF3S

SAE / NPT



NIPPLE

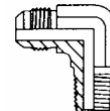

ELBOW

SAE	BSPT	Part No.	Part No.
5/8"	1/4"	X-6-4 FS-S	X-6 CS-S
5/8"	3/8"	X-6-6 FS-S	X-6-6 CS-S

BSPP*/ NPT



BSPP M X NPT M



BSPP F X NPT M

BSPP*	NPT	Part No.	Part No.
1/4"	1/4"	X-4-4FMK4S	X-1/4X1/4F4OHGS
3/8"	3/8"	X-6-6FMK4S	X-3/8 X 3/8 F4OHG-S
1/2"	1/2"	X-8-8FMK4S	X-1/2X1/2F4OHGS
3/4"	3/4"	X-12FMK4S	X-3/4 X 3/4 F4OHG-S
1"	1"	X-16FMK4S	

NPTF / BSPT



NPT F X BSPT M

NPT	BSPT	Part No.
1/8"	1/8"	X-1/8 X 1/8 F3HG-S
1/4"	1/4"	X-1/4X1/4F3HGS
3/8"	3/8"	X-3/8 X 3/8 F3HG-S
1/2"	1/2"	X-1/2 X 1/2 F3HG-S
3/4"	3/4"	X-3/4 X 3/4 F3HG-S
1"	1"	X-1 x 1 F3HG-S

* DOES NOT INCLUDE DOWTY SEAL

FOR STAINLESS STEEL—ADD AN EXTRA `S`

i.e. X-8 HTX-S => X-8 HTX-SS

STEEL CONVERSION ADAPTORS



JIC / UN ORING



NIPPLE

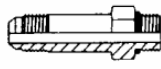

EXTENDED NIPPLE

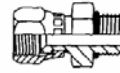

JIC F X UNO M

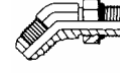

45deg ELBOW

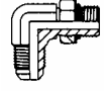

90 DEG ELBOW

JIC	UNO	Part No.	Part No.	Part No.	Part No.	Part No.
5/16"	5/16"	X-2 F50X-S				X-2 C50X-S
3/8"	3/8"	X-3 F50X-S				X-3 C50X-S
7/16"	7/16"	X-4 F50X-S	X-4 FF50X-S	X-4 F650X-S	X-4 V50X-S	X-4 C50X-S
7/16"	1/2"	X-4-5 F50X-S				X-4-6 C50X-S
7/16"	9/16"	X-4-6 F50X-S				X-5 C50X-S
7/16"	3/4"	X-4-8 F50X-S				X-5-6 C50X-S
1/2"	1/2"	X-5 F50X-S		X-5 F650X-S	X-5 V50X-S	X-6 C50X-S
1/2"	9/16"	X-5-6 F50X-S				X-6-4 C50X-S
1/2"	3/4"	X-5-8 F50X-S				
9/16"	7/16"	X-6-4 F50X-S				
9/16"	1/2"	X-6-5 F50X-S				X-6-5 C50X-S
9/16"	9/16"	X-6 F50X-S	X-6 FF50X-S	X-6 F650X-S	X-6 V50X-S	
9/16"	3/4"	X-6-8 F50X-S			X-6-8 V50X-S	X-6-8 C50X-S
9/16"	7/8"	X-6-10 F50X-S				X-6-10 C50X-S
9/16"	1 5/16"	X-6-16 F50X-S				
9/16"	1 5/8"	X-6-20 F50X-S				
3/4"	7/16"	X-8-4 F50X-S				
3/4"	9/16"	X-8-6 F50X-S				X-8-6 C50X-S
3/4"	3/4"	X-8 F50X-S	X-8 FF50X-S	X-8 F650X-S	X-8 V50X-S	X-8 C50X-S
3/4"	7/8"	X-8-10 F50X-S			X-8-10 V50X-S	X-8-10 C50X-S
3/4"	1 1/16"	X-8-12 F50X-S				X-8-12 C50X-S
3/4"	1 5/16"	X-8-16 F50X-S				X-8-16 C50X-S
3/4"	1 5/8"	X-8-20 F50X-S				
7/8"	9/16"	X-10-6 F50X-S				X-10-6 C50X-S
7/8"	3/4"	X-10-8 F50X-S				X-10-8 C50X-S
7/8"	7/8"	X-10 F50X-S	X-10 FF50X-S	X-10 F650X-S	X-10 V50X-S	X-10 C50X-S
7/8"	1 1/16"	X-10-12 F50X-S				X-10-12 C50X-S
7/8"	1 5/8"	X-10-20 F50X-S				
1 1/16"	3/4"	X-12-8 F50X-S				X-12-8 C50X-S
1 1/16"	7/8"	X-12-10 F50X-S			X-12-10 V50X-S	X-12-10 C50X-S
1 1/16"	1 1/16"	X-12 F50X-S	X-12 FF50X-S	X-12 F650X-S	X-12 V50X-S	X-12 C50X-S
1 1/16"	1 3/16"	X-12-14 F50X-S				
1 1/16"	1 5/16"	X-12-16 F50X-S				X-12-16 C50X-S
1 1/16"	1 5/8"	X-12-20 F50X-S				
1 3/16"	1 3/16"	X-14 F50X-S			X-14 V50X-S	X-14 C50X-S
1 3/16"	1 5/16"	X-14-16 F50X-S				
1 5/16"	7/8"	X-16-10 F50X-S				
1 5/16"	1 1/16"	X-16-12 F50X-S		X-16-12 F650X-S		X-16-12 C50X-S
1 5/16"	1 3/16"	X-16-14 F50X-S				
1 5/16"	1 5/16"	X-16 F50X-S	X-16 FF50X-S	X-16 F650X-S	X-16 V50X-S	X-16 C50X-S
1 5/16"	1 5/8"	X-16-20 F50X-S				X-16-20 C50X-S
1 5/8"	1 5/16"	X-20-16 F50X-S			X-20-16 V50X-S	X-20-16 C50X-S
1 5/8"	1 5/8"	X-20 F50X-S	X-20 FF50X-S	X-20 F650X-S	X-20 V50X-S	X-20 C50X-S
1 5/8"	1 7/8"	X-20-24 F50X-S				X-20-24 C50X-S
1 7/8"	1 5/8"	X-24-20 F50X-S				X-24 C50X-S
1 7/8"	1 7/8"	X-24 F50X-S			X-24 V50X-S	
2 1/2"	2 1/2"	X-32 F50X-S				X-32 C50X-S

FOR STAINLESS STEEL—ADD AN EXTRA `S' i.e. X-8 HTX-S => X-8 HTX-SS

STEEL CONVERSION ADAPTORS



JIC / UN ORING

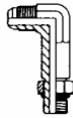

EXTENDED ELBOW

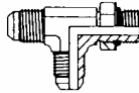

RUN TEE

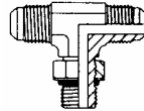

BRANCH TEE

JIC	UNO	Part No.	Part No.	Part No.
7/16"	7/16"	X-4 CC5OX-S	X-4 R5OX-S	X-4 S5OX-S
1/2"	1/2"		X-5 R5OX-S	X-5 S5OX-S
9/16"	7/16"			X-6-6-4 S5OX-S
9/16"	9/16"	X-6 CC5OX-S	X-6 R5OX-S	X-6 S5OX-S
3/4"	3/4"	X-8 CC5OX-S	X-8 R5OX-S	X-8 S5OX-S
7/8"	7/8"	X-10 CC5OX-S	X-10 R5OX-S	X-10 S5OX-S
1 1/16"	1 1/16"	X-12 CC5OX-S	X-12 R5OX-S	X-12 S5OX-S
1 5/16"	1 5/16"	X-16 CC5OX-S	X-16 R5OX-S	X-16 S5OX-S
1 5/8"	1 5/8"		X-20 R5OX-S	

BSPP* / BSPT



NIPPLE

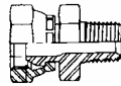

BSPP F X BSPT M

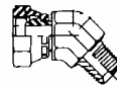

BSPP X BSPT 45DEG

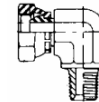

BSPP X BSPT 90DEG

BSPP*	BSPT	Part No.	Part No.	Part No.	Part No.
1/8"	1/8"	X-2F3MK4S			
1/8"	1/4"	X-2-4F3MK4S			
1/4"	1/8"	X-4F3MK4S	X-4F63HMK4S		
1/4"	1/4"	X-4-4F3MK4S	X-4-4F63HMK4S	X-1/4-4F3VMK46S	X-4-4C63MK4S
1/4"	3/8"	X-4-6F3MK4S	X-4-6F63HMK4S		
1/4"	1/2"	X-4-8F3MK4S			
3/8"	1/4"	X-6F3MK4S	X-6F63HMK4S		
3/8"	3/8"	X-6-6F3MK4S	X-6-6F63HMK4S	X-3/8-6F3VMK46S	X-6-6C63MK4S
3/8"	1/2"	X-6-8F3MK4S	X-6-8F63HMK4S		X-6-8C63MK4S
3/8"	3/4"	X-6-12F3MK4S			
1/2"	1/4"	X-8-4F3MK4S	X-8-4F63HMK4S		
1/2"	3/8"	X-8F3MK4S	X-8F63HMK4S		X-8C63MK4S
1/2"	1/2"	X-8-8F3MK4S	X-8-8F63HMK4S	X-1/2-8F3VMK46S	X-8-8C63MK4S
1/2"	5/8"	X-8-10F3MK4S			
1/2"	3/4"	X-8-12F3MK4S	X-8-12F63HMK4S		X-8-12C63MK4S
5/8"	5/8"	X-10-10F3MK4S			
3/4"	3/8"	X-12-6F3MK4S			
3/4"	1/2"	X-12-8F3MK4S	X-12-8F63HMK4S		X-12-8C63MK4S
3/4"	3/4"	X-12F3MK4S	X-12F63HMK4S	X-3/4-12F3VMK46S	X-12C63MK4S
3/4"	1"	X-12-16F3MK4S	X-12-16F63HMK4S		
3/4"	1 1/4"	X-12-20F3MK4S			
1"	3/4"	X-16-12F3MK4S	X-16-12F63HMK4S		
1"	1"	X-16F3MK4S	X-16F63HMK4S	X-1-16F3VMK46S	X-16C63MK4S
1"	1 1/4"	X-16-20F3MK4S			
1"	1 1/2"	X-16-24F3MK4S			
1 1/4"	1"	X-20-16F3MK4S			
1 1/4"	1 1/4"	X-20F3MK4S	X-20F63HMK4S		X-20C63MK4S
1 1/4"	1 1/2"	X-20-24F3MK4S			
1 1/2"	1 1/4"	X-24-20F3MK4S			
1 1/2"	1 1/2"	X-24F3MK4S			
2"	2"	X-32F3MK4S	X-32F63HMK4S		

FOR STAINLESS STEEL—ADD AN EXTRA `S` *i.e. X-8 HTX-S => X-8 HTX-SS*

STEEL CONVERSION ADAPTORS



BSPP* / UNO



BSPP x UNO



BSPP F X UNO M

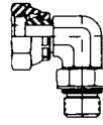

BSPPF X UNO M 90DEG

BSPP*	UNO	Part No.	Part No.	Part No.
1/4"	7/16"	X-4F5OMK4S		X-4C65OMK4S
1/4"	1/2"	X-4-5F5OMK4S		
1/4"	9/16"	X-4-6F5OMK4S	X-4-6F65OHMK4S	
1/4"	3/4"	X-4-8F5OMK4S		
3/8"	7/16"	X-6-4F5OMK4S		
3/8"	1/2"	X-6-5F5OMK4S		
3/8"	9/16"	X-6F5OMK4S		X-6C65OMK4S
3/8"	3/4"	X-6-8F5OMK4S	X-6-8F65OHMK4S	X-6-8C65OMK4S
3/8"	7/8"	X-6-10F5OMK4S	X-6-10F65OHMK4S	
1/2"	3/4"	X-8F5OMK4S	X-8F65OHMK4S	X-8C65OMK4S
1/2"	7/8"	X-8-10F5OMK4S	X-8-10F65OHMK4S	X-8-10C65OMK4S
1/2"	1 1/16"	X-8-12F5OMK4S		
3/4"	7/8"	X-12-10F5OMK4S		
3/4"	1 1/16"	X-12F5OMK4S	X-12F65OHMK4S	
3/4"	1 3/16"	X-12-14F5OMK4S		
3/4"	1 5/16"	X-12-16F5OMK4S		
1"	1 1/16"	X-16-12F5OMK4S		
1"	1 5/16"	X-16F5OMK4S	X-16F65OHMK4S	
1"	1 5/8"	X-16-20F5OMK4S		
1 1/4"	1 5/8"	X-20F5OMK4S		
1 1/2"	1 7/8"	X-20-24F5OMK4S		

* DOES NOT INCLUDE DOWTY SEAL

UNO / BSPT

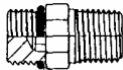

UNO X BSPT M

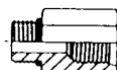

UNO X BSPT F



UNO X BSPT F 90DEG

UNO	BSPT	Part No.	Part No.	Part No.
7/16"	1/4"	X-4-1/4F5OHMF3S		
9/16"	1/4"	X-6-1/4F5OHMF3S		
9/16"	3/8"	X-6-3/8F5OHMF3S		X-6-3/8AOEMF3S
9/16"	1/2"	X-6-1/2F5OHMF3S		
3/4"	1/4"		X-8-4F5OHMG3S	
3/4"	3/8"	X-8-3/8F5OHMF3S		X-8-3/8AOEMF3S
3/4"	1/2"	X-8-1/2F5OHMF3S	X-8-8F5OHMG3S	X-8-1/2AOEMF3S
7/8"	3/8"	X-10-3/8F5OHMF3S		X-10-3/8AOEMF3S
7/8"	1/2"	X-10-1/2F5OHMF3S	X-10-8F5OHMG3S	X-10-1/2AOEMF3S
7/8"	3/4"	X-10-3/4F5OHMF3S		
1 1/16"	3/8"		X-12-6F5OHMG3S	
1 1/16"	1/2"	X-12-1/2F5OHMF3S		X-12-1/2AOEMF3S
1 1/16"	3/4"	X-12-3/4F5OHMF3S		X-12-3/4AOEMF3S
1 5/16"	1"	X-16-1F5OHMF3S		

FOR STAINLESS STEEL—ADD AN EXTRA `S' i.e. X-8 HTX-S => X-8 HTX-SS

STEEL CONVERSION ADAPTORS



JIC / METRIC PORT

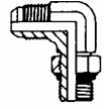

JIC X METRIC ISO6149

JIC X METRIC DIN 3852

JIC X METRIC ISO 6149

JIC X METRIC DIN 3852

JIC X METRIC ISO6149

JIC	METRIC	Part No.	Part No.	Part No.	Part No.	Part No.
7/16"	M10 X1.5	X-4M10F87OMXS		X-4M10F687OMXS		X-4M10C87OMXS
1/2"	M12 X1.5	X-5M12F87OMXS		X-5M12F687OMXS	X-5M12F68OMXS	X-5M12C87OMXS
9/16"	M14 X.15	X-6M14F87OMXS		X-6M14F687OMXS	X-6M14F68OMXS	X-6M14C87OMXS
9/16"	M16 X1.5	X-6M16F87OMXS				
9/16"	M18 X1.5	X-6M18F87OMXS				X-6M18C87OMXS
3/4"	M16 X1.5	X-8M16F87OMXS		X-8M16F687OMXS	X-8M16F68OMXS	X-8M16C87OMXS
3/4"	M18 X1.5	X-8M18F87OMXS				
3/4"	M22 X1.5		X-8M22F8OMXS			
7/8"	M18 X1.5	X-10M18F87OMXS				X-10M18C87OMXS
7/8"	M22 X1.5	X-10M22F87OMXS		X-10M22F687OMXS	X-10M22F68OMXS	X-10M22C87OMXS
1 1/16"	M22 X1.5	X-12M22F87OMXS				X-12M22C87OMXS
1 1/16"	M24 X1.5		X-12M24F8OMXS			
1 1/16"	M27X2	X-12M27F87OMXS	X-12M27F8OMXS	X-12M27F687OMXS	X-12M27F68OMXS	X-12M27C87OMXS
1 5/16"	M27X2		X-16M27F8OMXS			
1 5/16"	M33X2	X-16M33F87OMXS	X-16M33F8OMXS	X-16M33F687OMXS		X-16M33C87OMXS
1 5/8"	M42X2	X-20M42F87OMXS				

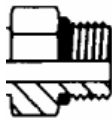

ISO 6149— Port Adaptor—O Ring

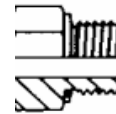

DIN 3852—Port Adaptor—Flat Face Port



Cutting Face with Cone Seat to mate with Tube or Hose Fitting.

KARCHER & GURNI ADATORS



KARCHER



GURNI

BSPT	METRIC	Part No.	Part No.
3/8"	M22 X 1.5	X-91CW-6-15-AU	X-jB5742

FOR STAINLESS STEEL—ADD AN EXTRA `S` i.e. X-8 HTX-S => X-8 HTX-SS

STEEL CONVERSION ADAPTORS



ORFS / UNO

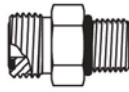

NIPPLE

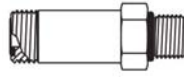

LONG NIPPLE

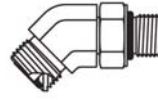

MALE 45 DEG ELBOW

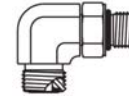

MALE 90DEG ELBOW

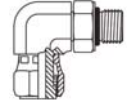

M/F ELBOW

ORFS	UNO	Part No.	Part No.	Part No.	Part No.	Part No.
9/16"	7/16"	X-4 F5OLO-S	X-4 FF5OLO-S	X-4 V5OLO-S	X-4 C5OLO-S	X-4 AOEL6-S
9/16"	9/16"	X-4-6 F5OLO-S		X-4-6 V5OLO-S		
9/16"	3/4"	X-4-8 F5OLO-S				
11/16"	7/16"	X-6-4 F5OLO-S		X-6-4 V5OLO-S	X-6-4 C5OLO-S	
11/16"	9/16"	X-6 F5OLO-S	X-6 FF5OLO-S	X-6 V5OLO-S	X-6 C5OLO-S	X-6 AOEL6-S
11/16"	3/4"	X-6-8 F5OLO-S		X-6-8 V5OLO-S	X-6-8 C5OLO-S	
11/16"	7/8"	X-6-10 F5OLO-S			X-6-10 C5OLO-S	
13/16"	9/16"	X-8-6 F5OLO-S		X-8-6 V5OLO-S	X-8-6 C5OLO-S	
13/16"	3/4"	X-8 F5OLO-S	X-8 FF5OLO-S	X-8 V5OLO-S	X-8 C5OLO-S	X-8 AOEL6-S
13/16"	7/8"	X-8-10 F5OLO-S		X-8-10 V5OLO-S	X-8-10 C5OLO-S	
13/16"	1 1/16"	X-8-12 F5OLO-S			X-8-12 C5OLO-S	
13/16"	1 5/16"	X-8-16 F5OLO-S				
1"	3/4"	X-10-8 F5OLO-S		X-10-8 V5OLO-S	X-10-8 C5OLO-S	
1"	7/8"	X-10 F5OLO-S	X-10 FF5OLO-S	X-10 V5OLO-S	X-10 C5OLO-S	X-10 AOEL6-S
1"	1 1/16"	X-10-12 F5OLO-S		X-10-12 V5OLO-S	X-10-12 C5OLO-S	
1 3/16"	3/4"	X-12-8 F5OLO-S			X-12-8 C5OLO-S	
1 3/16"	7/8"	X-12-10 F5OLO-S		X-12-10 V5OLO-S	X-12-10 C5OLO-S	
1 3/16"	1 1/16"	X-12 F5OLO-S	X-12 FF5OLO-S	X-12 V5OLO-S	X-12 C5OLO-S	X-12 AOEL6-S
1 3/16"	1 5/16"	X-12-16 F5OLO-S		X-12-16 V5OLO-S	X-12-16 C5OLO-S	
1 7/16"	1 1/16"	X-16-12 F5OLO-S		X-16-12 V5OLO-S	X-16-12 C5OLO-S	
1 7/16"	1 5/16"	X-16 F5OLO-S	X-16 FF5OLO-S	X-16 V5OLO-S	X-16 C5OLO-S	X-16 AOEL6-S
1 7/16"	1 5/8"	X-16-20 F5OLO-S		X-16-20 V5OLO-S	X-16-20 C5OLO-S	
1 11/16"	1 5/16"	X-20-16 F5OLO-S			X-20-16 C5OLO-S	
1 11/16"	1 5/8"	X-20 F5OLO-S	X-20 FF5OLO-S	X-20 V5OLO-S	X-20 C5OLO-S	X-20 AOEL6-S
1 11/16"	1 7/8"	X-20-24 F5OLO-S			X-20-24 C5OLO-S	
2"	1 5/8"	X-24-20 F5OLO-S			X-24-20 C5OLO-S	
2"	1 7/8"	X-24 F5OLO-S	X-24 FF5OLO-S	X-24 V5OLO-S	X-24 C5OLO-S	X-24 AOEL6-S

ORFS / UNO

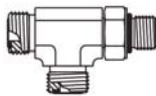

Male Run Tee

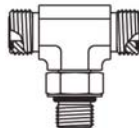

Male Branch Tee - ORFS / UNO / ORFS

ORFS	UNO	Part No.	Part No.
9/16"	7/16"	X-4 R5OLO-S	X-4 S5OLO-S
11/16"	9/16"	X-6 R5OLO-S	X-6 S5OLO-S
13/16"	3/4"	X-8 R5OLO-S	X-8 S5OLO-S
1"	7/8"	X-10 R5OLO-S	X-10 S5OLO-S
1 3/16"	1 1/16"	X-12 R5OLO-S	X-12 S5OLO-S
1 7/16"	1 5/16"	X-16 R5OLO-S	X-16 S5OLO-S
1 11/16"	1 5/8"	X-20 R5OLO-S	X-20 S5OLO-S
2"	1 7/8"	X-24 R5OLO-S	X-24 S5OLO-S

FOR STAINLESS STEEL—ADD AN EXTRA `S`

i.e. X-8 HTX-S => X-8 HTX-SS

STEEL CONVERSION ADAPTORS



**FLUID HANDLING
SOLUTIONS**

ORFS / BSPP (CAPTIVE SEAL)

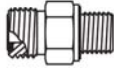

NIPPLE

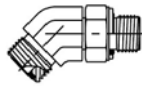

MALE 45DEG ELBOW

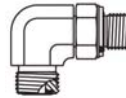

MALE 90DEG ELBOW

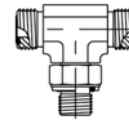

MALE BRANCH TEE

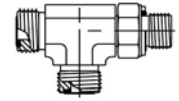

MALE RUN TEE

ORFS	BSPP	Part No.	Part No.	Part No.	Part No.	Part No.
9/16"	1/8"	X-4F42EDMLOS	X-4V4OMLOS	X-4C4OMLOS		X-4R4OMLOS
9/16"	1/4"	X-4-4F42EDMLOS	X-4-4V4OMLOS	X-4-4C4OMLOS	X-4-4-4S4OMLOS	
9/16"	3/8"	X-4-6F42EDMLOS		X-4-6C4OMLOS		
9/16"	1/2"	X-4-8F42EDMLOS				
11/16"	1/8"	X-6-2F42EDMLOS				
11/16"	1/4"	X-6F42EDMLOS	X-6V4OMLOS	X-6C4OMLOS	X-6S4OMLOS	X-6R4OMLOS
11/16"	3/8"	X-6-6F42EDMLOS	X-6-6V4OMLOS	X-6-6C4OMLOS	X-6-6-6S4OMLOS	X-6-6-6R4OMLOS
11/16"	1/2"	X-6-8F42EDMLOS	X-6-8V4OMLOS	X-6-8C4OMLOS		
11/16"	3/4"	X-6-12F42EDMLOS				
13/16"	1/4"	X-8-4F42EDMLOS		X-8-4C4OMLOS		
13/16"	3/8"	X-8F42EDMLOS	X-8V4OMLOS	X-8C4OMLOS	X-8S4OMLOS	X-8R4OMLOS
13/16"	1/2"	X-8-8F42EDMLOS		X-8-8C4OMLOS	X-8-8-8S4OMLOS	X-8-8-8R4OMLOS
13/16"	3/4"	X-8-12F42EDMLOS		X-8-12C4OMLOS		
1"	3/8"	X-10-6F42EDMLOS		X-10-6C4OMLOS		
1"	1/2"	X-10F42EDMLOS	X-10V4OMLOS	X-10C4OMLOS	X-10S4OMLOS	X-10R4OMLOS
1"	3/4"	X-10-12F42EDMLOS	X-10-12V4OMLOS	X-10-12C4OMLOS	X-10-10-12S4OMLOS	X-10-12-10R4OMLOS
1"	1"	X-10-16F42EDMLOS		X-10-16C4OMLOS		
1 3/16"	1/2"	X-12-8F42EDMLOS		X-12-8C4OMLOS		
1 3/16"	3/4"	X-12F42EDMLOS	X-12V4OMLOS	X-12C4OMLOS	X-12S4OMLOS	X-12R4OMLOS
1 3/16"	1"	X-12-16F42EDMLOS	X-12-16V4OMLOS	X-12-16C4OMLOS		X-12-16-12R4OMLOS
1 7/16"	3/4"	X-16-12F42EDMLOS		X-16-12C4OMLOS		
1 7/16"	1"	X-16F42EDMLOS	X-16V4OMLOS	X-16C4OMLOS		X-16R4OMLOS
1 7/16"	1 1/4"	X-16-20F42EDMLOS		X-16-20C4OMLOS		
1 7/16"	1 1/2"	X-16-24F42EDMLOS				
1 11/16"	1"	X-20-16F42EDMLOS		X-20-16C4OMLOS		
1 11/16"	1 1/4"	X-20F42EDMLOS		X-20C4OMLOS		
1 11/16"	1 1/2"	X-20-24F42EDMLOS		X-20-24C4OMLOS		
2"	1 1/2"	X-24F42EDMLOS		X-24C4OMLOS		

ORFS / JIC



ORFS M X JIC M

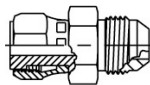

ORFS F X JIC FM

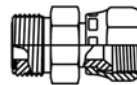

ORFS M x JIC F S/W

ORFS	JIC	Part No.	Part No.	Part No.
9/16"	7/16"	X-4 XHLO-S	X-4 XHL6-S	X-4 LOHX6-S
11/16"	9/16"	X-6 XHLO-S	X-6 XHL6-S	X-6 LOHX6-S
13/16"	3/4"	X-8 XHLO-S	X-8 XHL6-S	X-8 LOHX6-S
1"	7/8"	X-10 XHLO-S	X-10 XHL6-S	X-10 LOHX6-S
1 3/16"	1 1/16"	X-12 XHLO-S	X-12 XHL6-S	X-12 LOHX6-S
1 7/16"	1 5/16"	X-16 XHLO-S	X-16 XHL6-S	X-16 LOHX6-S
1 11/16"	1 5/8"	X-20 XHLO-S	X-20 XHL6-S	
2"	1 7/8"	X-24 XHLO-S		

FOR STAINLESS STEEL—ADD AN EXTRA 'S'

i.e. X-8 HTX-S => X-8 HTX-SS

STEEL CONVERSION ADAPTORS



CODE 61 / JIC

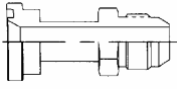

STRAIGHT
(X-15T3-**-*)

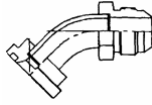

45DEG TUBE
(X-17T3-**-*)

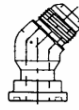

45DEG COMPACT
(X-**XVQ1-S)

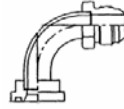

90DEG TUBE
(19T3-**-*)

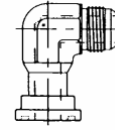

90DEG COMPACT
(**XEQ1-S)

CODE 62 / JIC



STRAIGHT TUBE
(X-6AH3-**-*)



STRAIGHT
(X-**XHQ2-S)

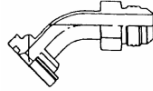

45DEG TUBE
(X-6FH3-**-*)



45DEG TUBE
(X-**XVQ2-S)

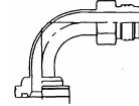

90DEG TUBE
(X-6NH3-**-*)

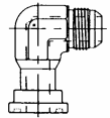

COMPACT 90DEG
(X-** XEQ2-S)

CODE 61 / ORFS

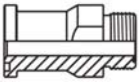

FLANGE X ORFS
(X-** LOHQ1-S)

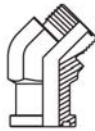

FLANGE X ORFS 45DEG
(X-** LOVQ1-S)

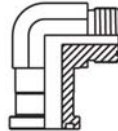

FLANGE X ORFS 90DEG
(X-** LOEQ1-S)

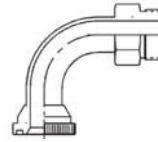

FLANGE X TUBE ORFS 90DEG
(X-4NJM-**-**)

CODE 62 / ORFS

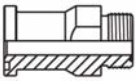

FLANGE X ORFS
(X-** LOHQ2-S)

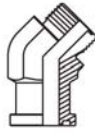

FLANGE X ORFS 45DEG
(X-**LOVQ2-S)

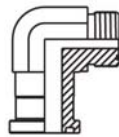

FLANGE X ORFS 90DEG
(X-** LOEQ2-S)

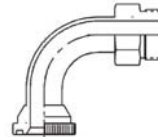

FLANGE X ORFS 90DEG
(X-6NJM-**-**)

FLANGE KITS

(contains 2 x halves, bolts and washers complete)

SAE CODE 61

SAE CODE 62

FLANGE SIZE	Part No.	Part No.
1/2"	X-5151HK-8	
3/4"	X-5151HK-12	X-HFHFK-12
1"	X-5151HK-16	X-HFHFK-16
1 1/4"	X-5151HK-20	X-HFHFK-20
1 1/2"	X-5151HK-24	X-HFHFK-24
2"	X-5151HK-32	X-HFHFK-32

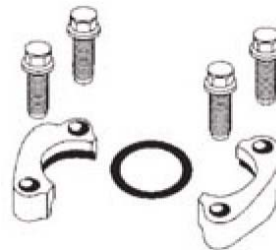

FOR STAINLESS STEEL—ADD AN EXTRA `S`

i.e. X-8 HTX-S => X-8 HTX-SS